

FLXL Series

Extra Large Flood



FLXL Series

SPECIFICATIONS

- Die Cast Aluminum Housing
- Tempered Clear Flat Glass Lens
- Wide Angle Aluminum Reflector
- Uniformed Poured Silicone Gasket
- Bronze Powder Coat Finish, Optional Custom Color
- HID Porcelain Mogul Base 5KV Socket
- Stainless Steel Hardware
- Multiple Light Source Options
- Optional Wire Guard, Glare Shield or Vandal Guard

APPLICATIONS

- General Area/Flood Lighting
- Walkways, Parking, Roadway, Area
- Schools, Commercial Buildings, Communities
- Street Lighting, Car Lots, Campuses

ELECTRICAL

- Quad Volt: HPS & MH 400W & 1000W & PMH 400W, 750W & 1000W
- 480V: HPS & MH 400W & 1000W & PMH 400W, 750W & 1000W

INSTALLATION

- Mounts with 6" Mounting Arm (Round or Square) for Direct Pole Mount or Adjustable Slip Fitter, U-Bracket or Yoke Mount

CERTIFICATIONS/LISTINGS

- CSA Listed
- Listed for Wet Locations



PROJECT _____ TYPE _____

QTY _____ NOTES _____ APPROVAL _____

ORDERING/SPECIFYING INFORMATION:

EXAMPLE: FLXL M 1000 Q L

FLXL	[]	[]	[]	[]
Series	Light Source	Volts		Options
	H High Pressure Sodium M Metal Halide P Pulse Start Metal Halide	Q 120/208/240/277V 480 480V		
	Watts			
	HPS	MH	PMH	
	400	400	400	
	1000	1000	750	
			1000	
				L Lamped A6 A6" Arm A6R A6"R Arm ASF Adjustable Slip Fitter UB U-Bracket LY Large Yoke WG Wire Guard GS Glare Shield VG Vandal Guard CC Custom Color

SPECIFICATIONS

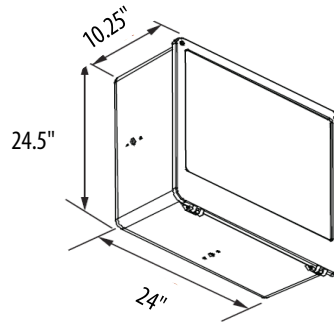

OPTIONS/ACCESSORIES



A6 (R) 6" Arm

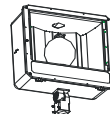

ASF Adjustable Slip Fitter

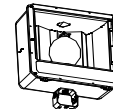

UB U-Bracket

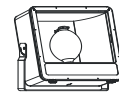

LY Large Yoke



WG Wire Guard



GS Glare Shield

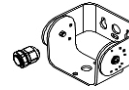

VG Vandal Guard

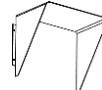
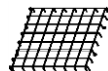

Specifications Subject to Change

